



# PRECISION SERIES GAS HOT PLATES

Model Numbers: HP-2, HP-4, HP-6

## FEATURES

- Heavy-Duty Stainless Construction
- Heavy Cast Iron Grates
- Powerful Cast Iron Burners
- Adjustable Stainless Legs
- All Stainless Drip Pan
- Simple, Efficient Design
- Independent Gas Controls
- Chrome-Plated, Heavy-Duty Control Knobs



HP-2



HP-4



HP-6

See Reverse Side for Product Specifications

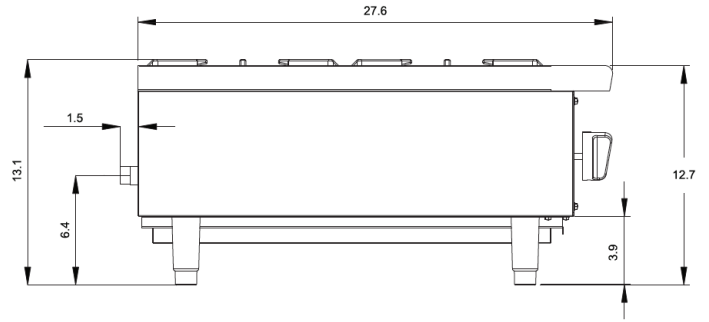

# PRECISION SERIES GAS HOT PLATE SPECIFICATIONS

Model Numbers: HP-2, HP-4, HP-6

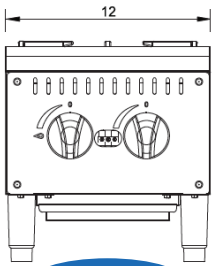

**HP-2**

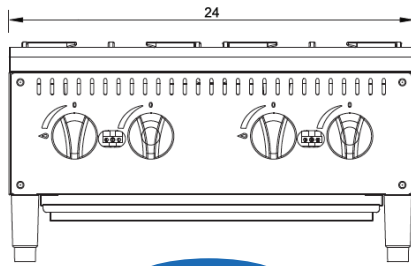

**HP-4**

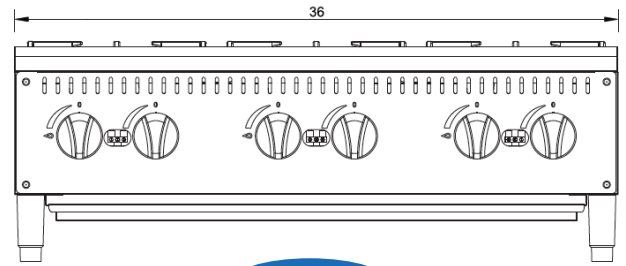

**HP-6**

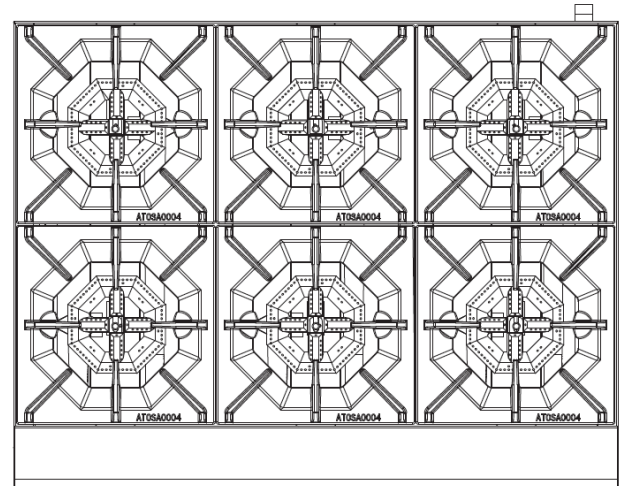
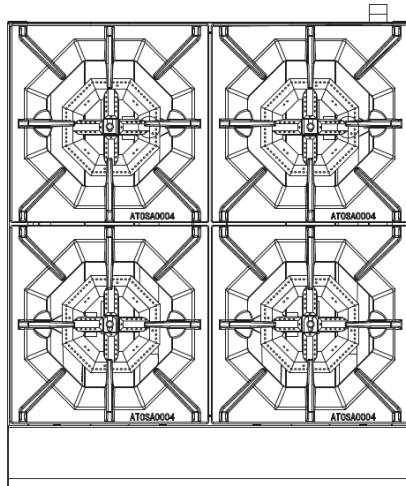
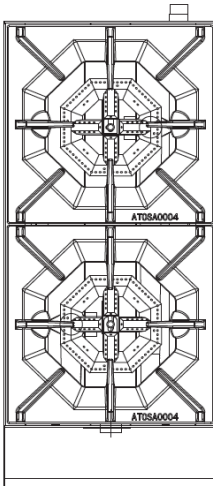

Model	Burners and Control Method	Gas Type	Intake-Tube Pressure (in.W.C.)	Per BTU B.T.U./h	Total BTU B.T.U./h	Nozzle No.	Net Weight (LBS)
HP-2	2 Burners Independent Manual Control	NG	4	25,000	50,000	#43	55.1
		LP	10	25,000	50,000	#53	
HP-4	4 Burners Independent Manual Control	NG	4	25,000	100,000	#43	97
		LP	10	25,000	100,000	#53	
HP-6	6 Burners Independent Manual Control	NG	4	25,000	150,000	#43	136.7
		LP	10	25,000	150,000	#53	



NORTH AMERICAN RESTAURANT EQUIPMENT

**Call Us Today! (401) 639-3271**

Email: [naequipment@gmail.com](mailto:naequipment@gmail.com)